

MOTOPLASTIC, S.A.

Molí de la sal, 1 - 08403 Granollers (Barcelona) SPAIN

Tel. 34 93 849 06 33 - Fax 34 93 849 09 88

info@puig.tv

- info@puigusa.com

www.puig.tv









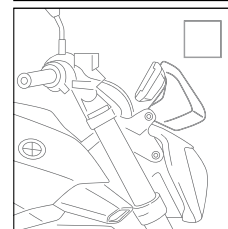
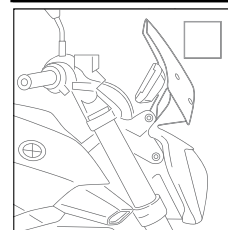
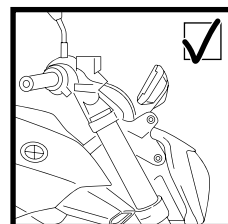



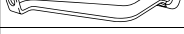
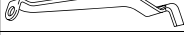

- www.puigusa.com

Ref.: 8110

INSTRUCCIONES DE MONTAJE - MOUNTING INSTRUCTIONS - MONTAGEANLEITUNG

CARENABRÍS TOURING ADAPTABLE A - TOURING WINDSHIELD FOR - WINDSCHUTZSCHEIBE TOURING FÜR BMW R1200R '15 -



ID	PIEZA / PART	DESCRIPCIÓN	DESCRIPTION	QTY	REF.
1		Carenabrís Touring	Touring windshield	1	8165F/H/N/WM3
2		Soporte metálico derecho	Right metal support	1	SOPOR-2P-4-8165
3		Soporte metálico izquierdo	Left metal support	1	SOPOR-2P-4-8165
4		Casquillo metálico Ø int. 8,5 x Ø ext. 14x20 mm	Ø inner 8,5 x Ø outer 14x20 mm arrowhead	2	CASQUI-----659
5		Tornillo Allen DIN 912 M8x40 (negro)	DIN 912 M8x40 (black) Allen screw	2	TORNI-AD912-475
6		Soporte metálico derecho de refuerzo	Right metal reinforcement support	1	SOPOR-2P-2-8168
7		Soporte metálico izquierdo de refuerzo	Left metal reinforcement support	1	SOPOR-2P-2-8168
8		Casquillo metálico Ø int. 8,5 x Ø ext. 14x12 mm	Ø inner 8,5 x Ø outer 14x12 mm arrowhead	2	CASQUI-----0083
9		Tornillo Allen DIN 912 M8x45 (negro)	DIN 912 M8x45 (black) Allen screw	2	TORNI-AD912-508
10		Arandela de goma M5x4	M5x4 rubber washer	4	ARAND-GD13D5X4-
11		Silentblock M5	M5 Silentblock	2	SILENBTM5-046/1
12		Arandela de nylon M5x0,5	M5x0,5 nylon washer	6	ARNV00000000245
13		Tornillo Allen M5x16 ISO 7380 (negro)	M5x16 ISO 7380 (black) Allen screw	8	TORNI-I7380-493
14		Tapón tornillo M5 ISO 7380	M5 ISO 7380 Allen screw cap	4	TAPON_____85
15		Separador de silicona Ø8x2 (se suministra montado)	Ø8x2 Silicon adhesive spacer (supplied mounted)	1	ADHESI-GT-D8---
16		Visera metálica (visera para eviatar el posible "efecto lupa")	Metal visor (visor to avoid magnifying glass effect)	1	VISERA1P-3-8165

MOTOPLASTIC, S.A.

Molí de la sal, 1 - 08403 Granollers (Barcelona) SPAIN

Tel. 34 93 849 06 33 - Fax 34 93 849 09 88

info@puig.tv - info@puigusa.com

www.puig.tv - www.puigusa.com

INSTRUCCIONES DE MONTAJE - MOUNTING INSTRUCTIONS - MONTAGEANLEITUNG

CARENABRÍS TOURING ADAPTABLE A - TOURING WINDSHIELD FOR - WINDSCHUTZSCHEIBE TOURING FÜR BMW R1200R '15 -

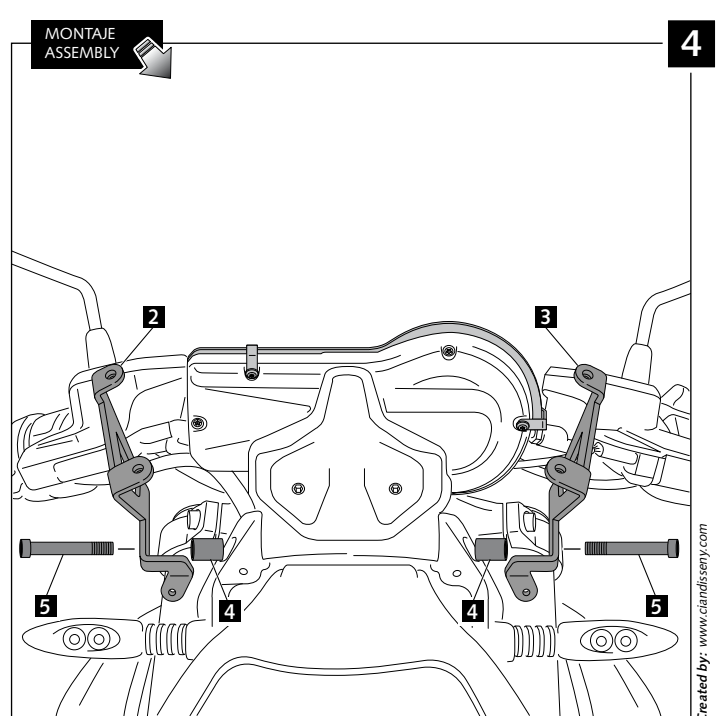
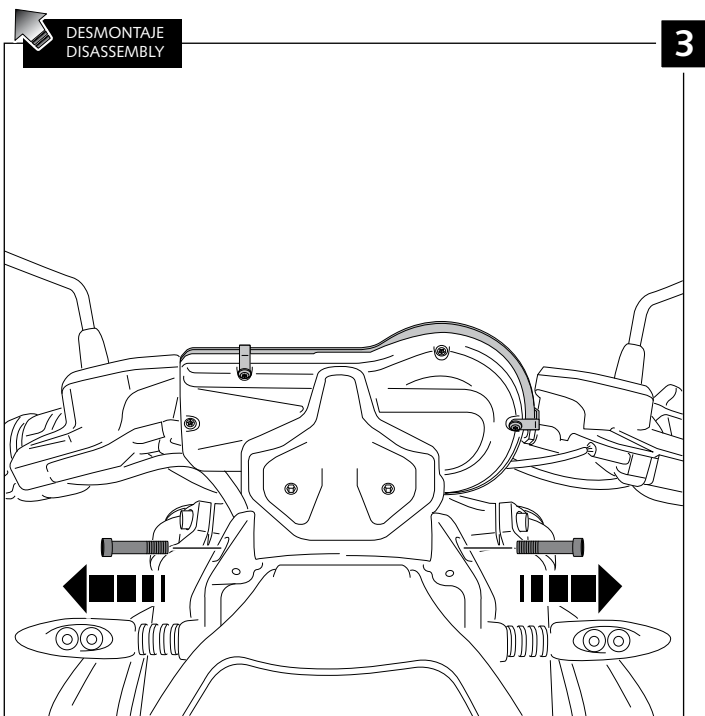
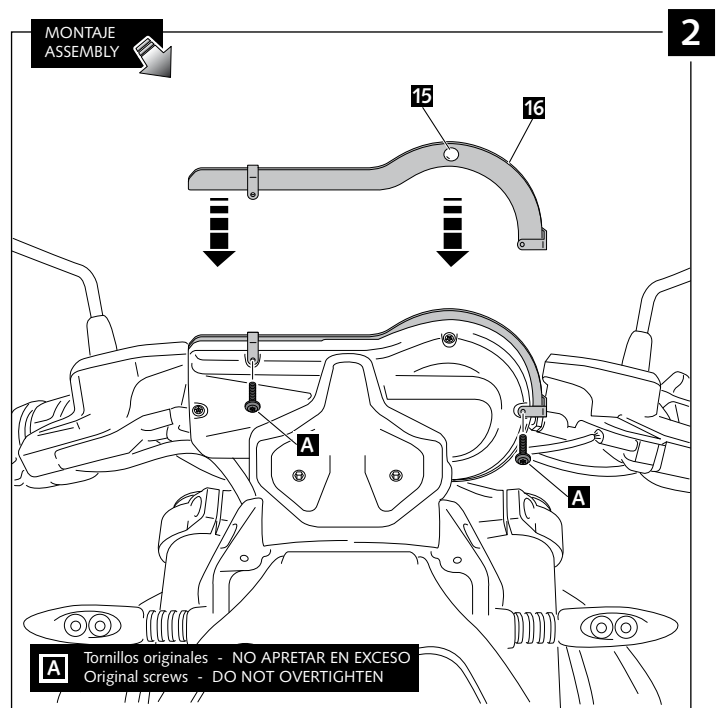
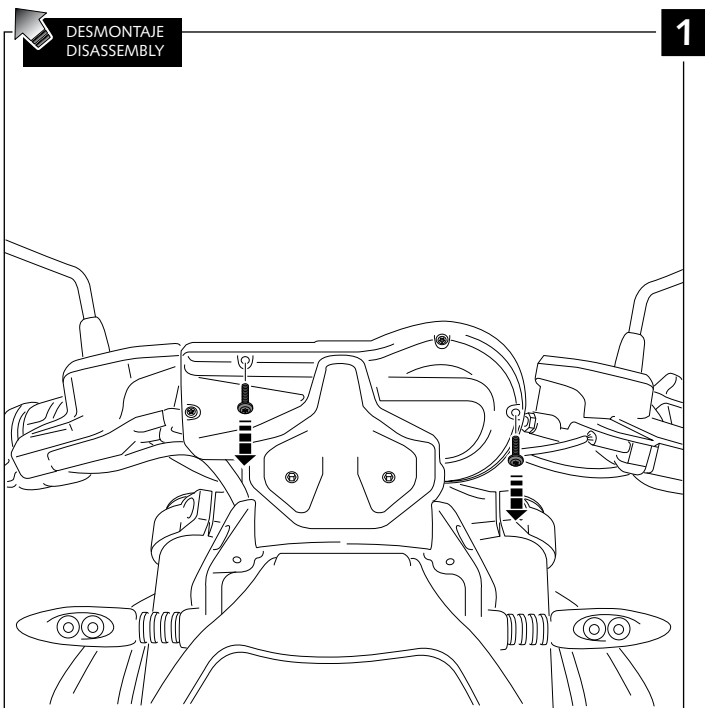

MOTOPLASTIC, S.A.

Molí de la sal, 1 - 08403 Granollers (Barcelona) SPAIN

Tel. 34 93 849 06 33 - Fax 34 93 849 09 88

info@puig.tv - info@puigusa.com

www.puig.tv - www.puigusa.com

INSTRUCCIONES DE MONTAJE - MOUNTING INSTRUCTIONS - MONTAGEANLEITUNG

CARENABRÍS TOURING ADAPTABLE A - TOURING WINDSHIELD FOR - WINDSCHUTZSCHEIBE TOURING FÜR BMW R1200R '15 -

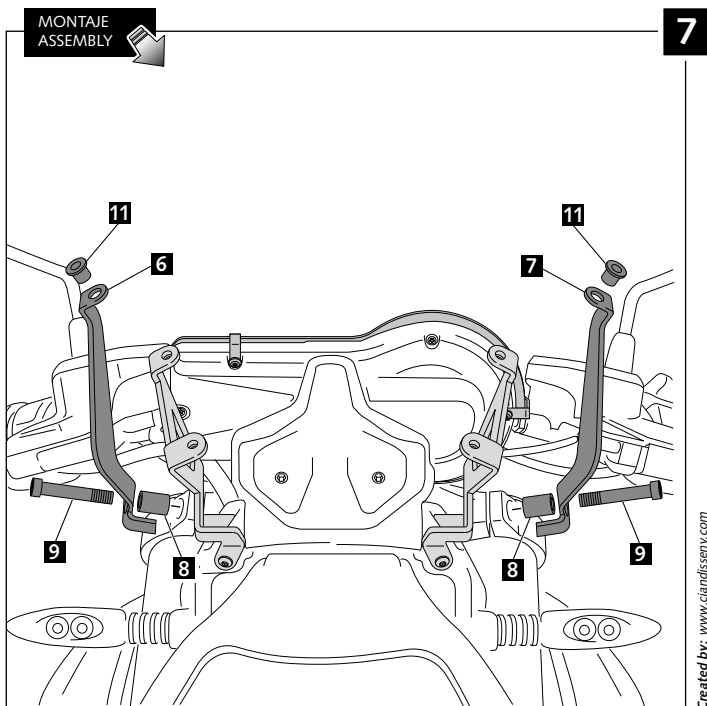
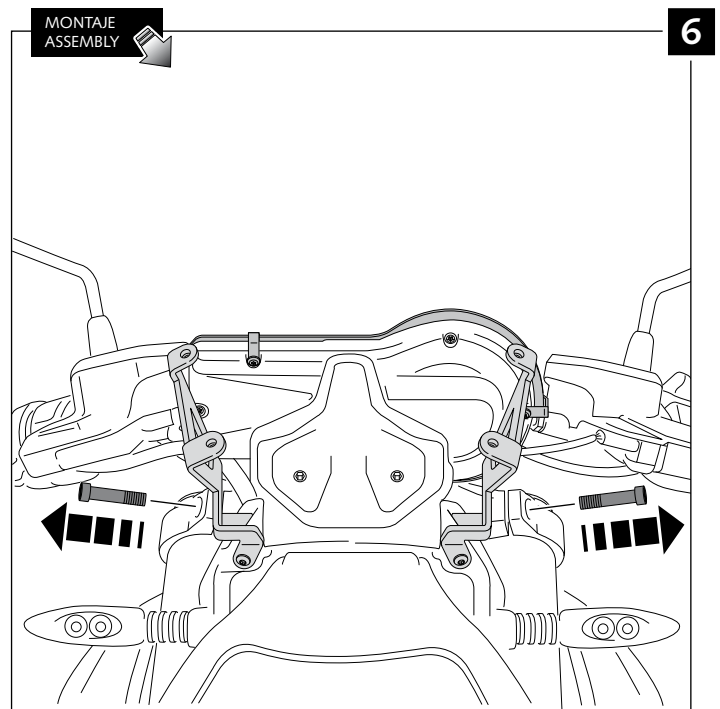
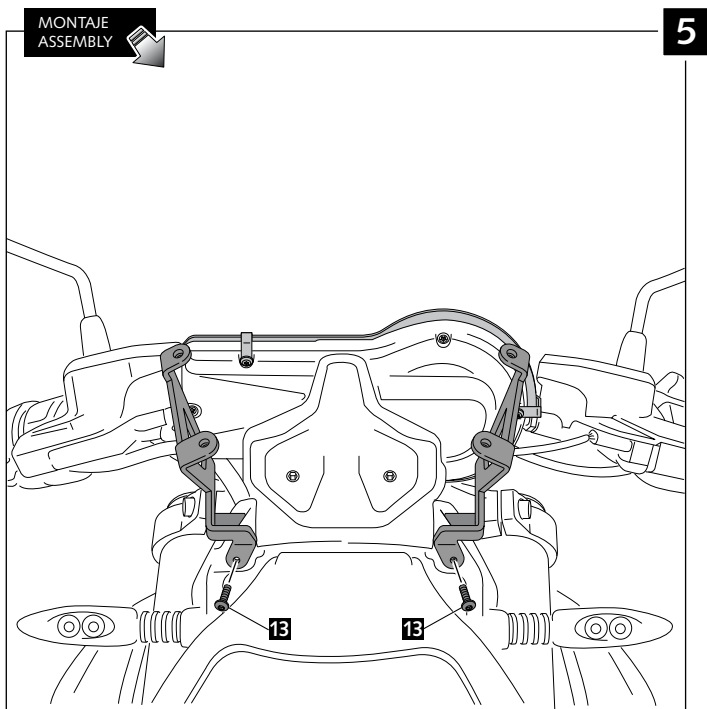

Created by: www.candisseny.com

CONTINUA
CONTINUOUS

MOTOPLASTIC, S.A.

Molí de la sal, 1 - 08403 Granollers (Barcelona) SPAIN

Tel. 34 93 849 06 33 - Fax 34 93 849 09 88

info@puig.tv - info@puigusa.com

www.puig.tv - www.puigusa.com

INSTRUCCIONES DE MONTAJE - MOUNTING INSTRUCTIONS - MONTAGEANLEITUNG

CARENABRÍS TOURING ADAPTABLE A - TOURING WINDSHIELD FOR - WINDSCHUTZSCHEIBE TOURING FÜR BMW R1200R '15 -

MONTAJE
ASSEMBLY

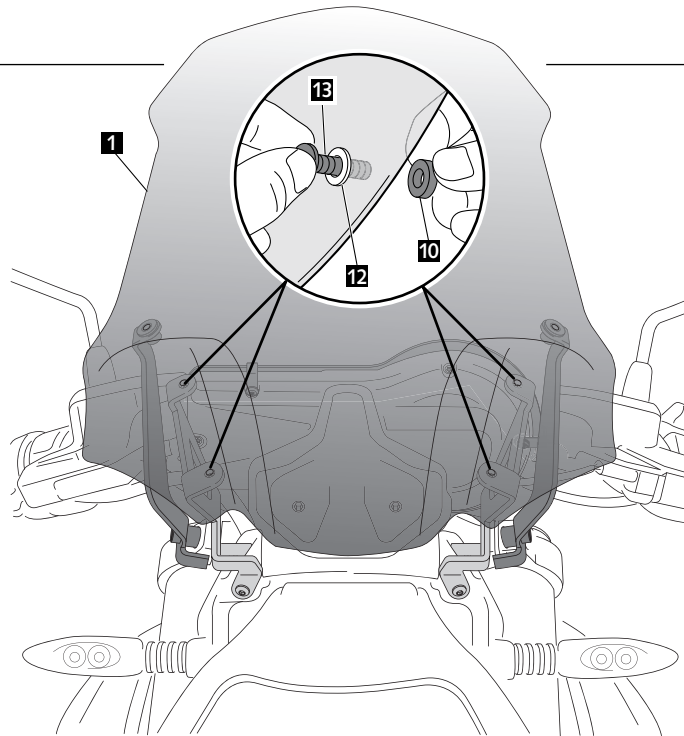

8

MONTAJE
ASSEMBLY

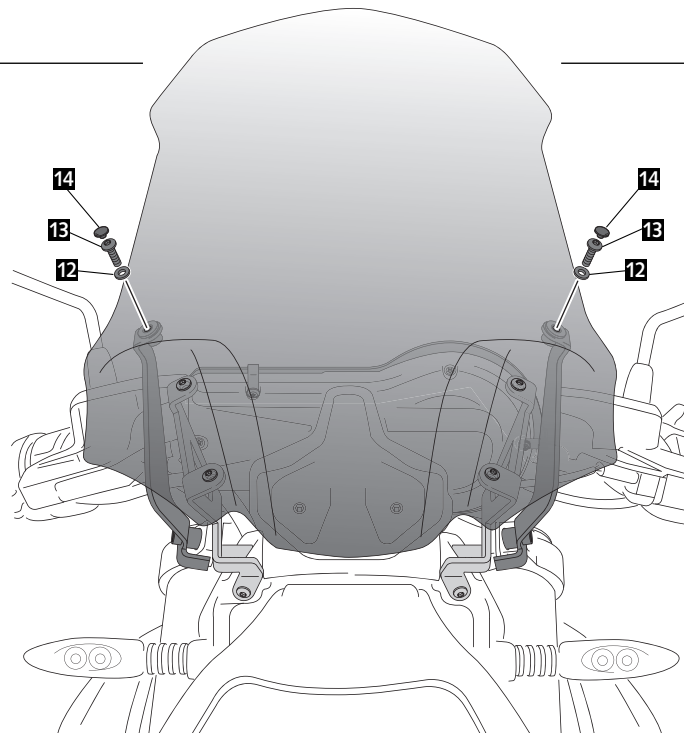

9